

PRODUCT PROFILE

ElectroCell's Xcell-2000

500 – 1500 Ton Applications

Hi-Tech Filtration System



Product Description

Fully automated side-stream filter designed to operate in Open Condenser Loops
500 to 1500 ton applications.

Features:

- PLC with color touch screen
- Stainless Steel Construction
- Fully Automated
- Conductivity Meter
- Skid Mounted Modular Assembly
- Circulating Pump with VFD
- Make-up, Bleed and Evaporation Totalization
- Control of TSS and TDS
- PC Interface
- Local and Remote Monitoring and Control
- Alarms and Trending

Typical Applications (Commercial / Industrial):

- Cooling Towers
- Process Water
- Process Liquids

.... And more

PRODUCT PROFILE

ElectroCell's Xcell-2000

Hi-Tech Filtration System

500 – 1500 Ton Applications

Specifications / Physical Description

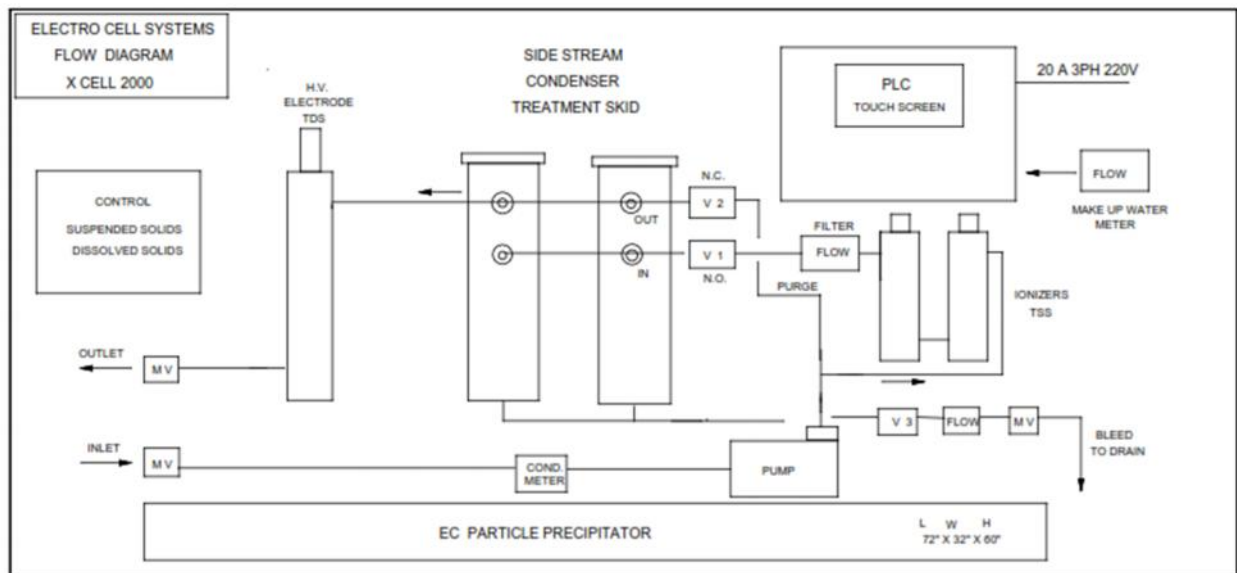

Weight:	600 lbs
Footprint:	72" L x 32" W x 60" H
PSI (maximum):	150 psi
Electrical:	3-Phase, 220V or 440V AC, 3.6 / 1.8 Amps
Pump:	1-hp circulating pump
Piping:	Inlet: 2" Outlet: 2" Discharge: 1"

ElectroCell Systems

3320 Nazareth Road, Easton, PA 18045

Toll Free (800) 949-3445

E-mail: info@electrocellsystems.com

Web: www.electrocellsystems.com